



Representative photograph, actual product appearance may vary.

Due to regional agency approval requirements, some products may not be available in your area. Please contact your regional Honeywell office regarding your product of choice.

RA20NASD502A
RA20 Series Industrial Potentiometer, Wire Wound Element, Solder lug Terminals, 2 W Power Rating, 5 kOhm Resistance Value

Features

- Robust nickel-plated brass shaft and bushings
- Wirewound element
- Linear taper
- Very stable over the operating temperature
- Meets MIL-R-19 standards

Typical Applications

- Manual controls
- Welding and heating

Description

The RA20 Series is a military qualified potentiometer made in accordance to MIL-R-19 specifications. It offers a 2 watt power rating and a wirewound element.



RA20NASD502A
RA20 Series Industrial Potentiometer, Wire Wound Element, Solder lug Terminals, 2 W Power Rating, 5 kOhm Resistance Value

Product Specifications	
Potentiometer Type	Industrial
Element Type	Wire Wound
Terminal Type	Solder lug
Power Rating	2 W
Resistance Value	5 kOhm
Resistance Tolerance	± 10 %
Linearity	± 5 %

Bushing Thread	9,53 mm [0.375 in] x 32 NEF-2A
Bushing length	9,53 mm [0.375 in]
Bushing Type	Standard
Shaft Diameter	6,35 mm [0.25 in]
Shaft length	22,23 mm [0.875 in]
Shaft Ending	Slotted
Body	28.6 mm [1.125 in] diameter, \pm 0.79 mm [0.031 in], except at terminal standoff
Electrical Taper	Linear
Operating Temperature	-55 °C to 105 °C [-67 °F to 220 °F]
Working Voltage (Max.)	310 V
Rotational Life	10000 cycles
Mechanical Rotation	300°
Availability	Global
Series Name	RA20 Series
UNSPSC Code	4111363300
UNSPSC Commodity	4111363300 Potentiometers

Honeywell

RA20NASD502A

RA20 Series Industrial Potentiometer, Wire Wound Element, Solder lug Terminals, 2 W Power Rating, 5 kOhm Resistance Value

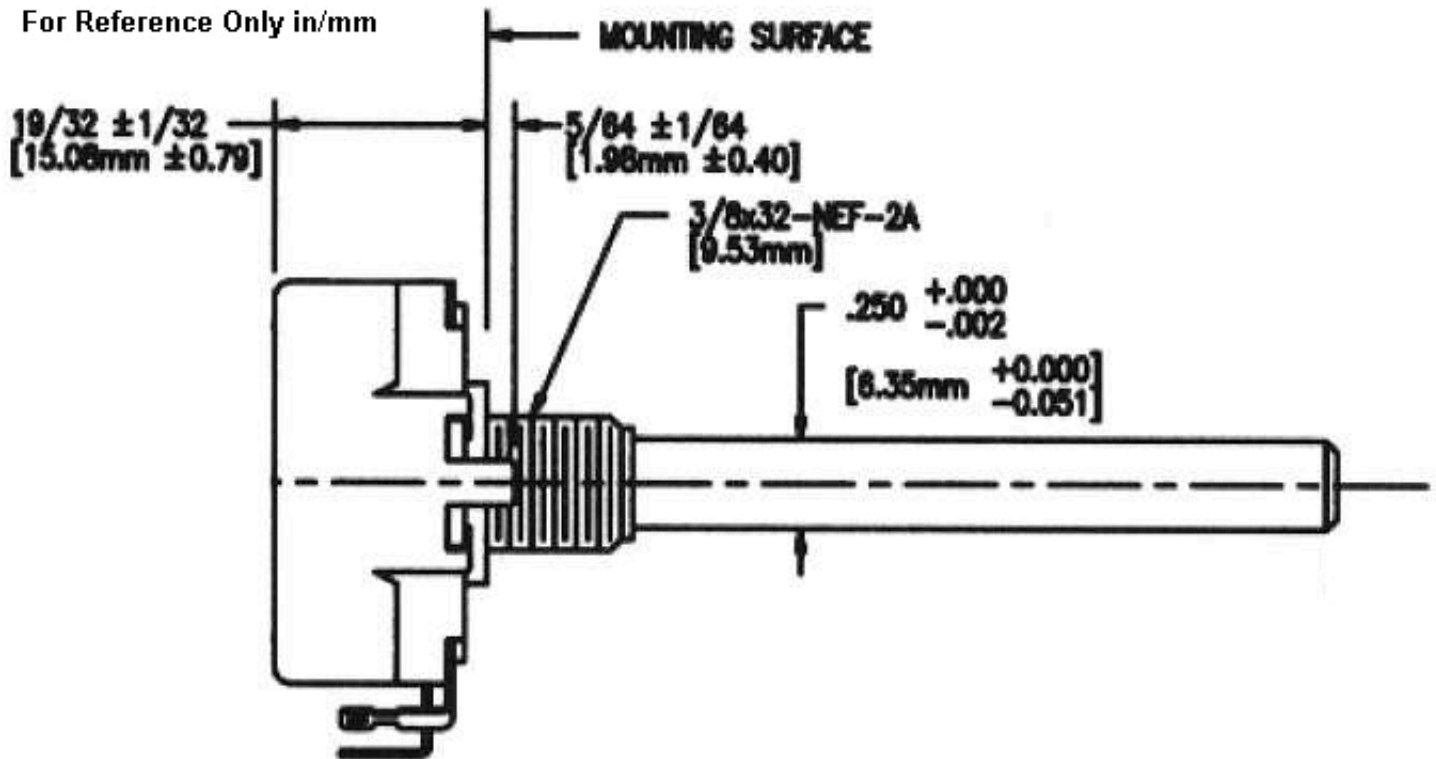

Honeywell

RA20NASD502A

RA20 Series Industrial Potentiometer, Wire Wound Element, Solder Lug Terminals, 2 W Power Rating, 5 kOhm Resistance Value

WARNING

PERSONAL INJURY

DO NOT USE these products as safety or emergency stop devices, or in any other application where failure of the product could result in personal injury.

Failure to comply with these instructions could result in death or serious injury.

WARNING

MISUSE OF DOCUMENTATION

- The information presented in this product sheet (or catalog) is for reference only. DO NOT USE this document as product installation information.
- Complete installation, operation and maintenance information is provided in the instructions supplied with each product.

Failure to comply with these instructions could result in death or serious injury.

© Copyright Honeywell Inc. 1998-2004 All rights reserved.